

Tom 34 3x3

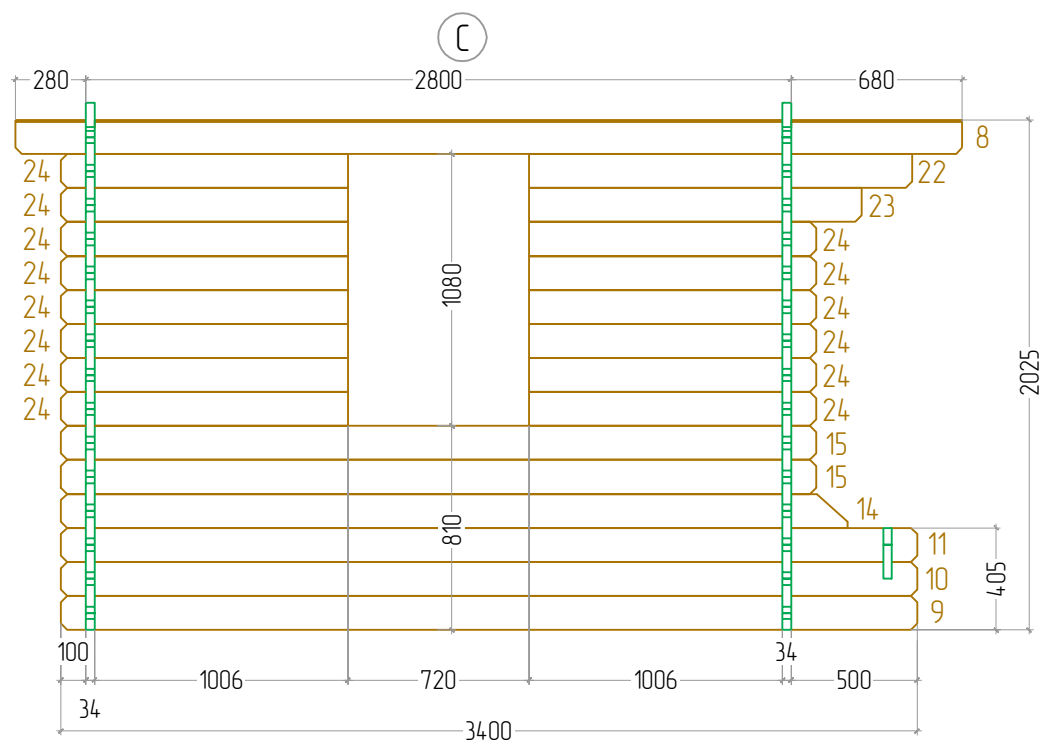

D

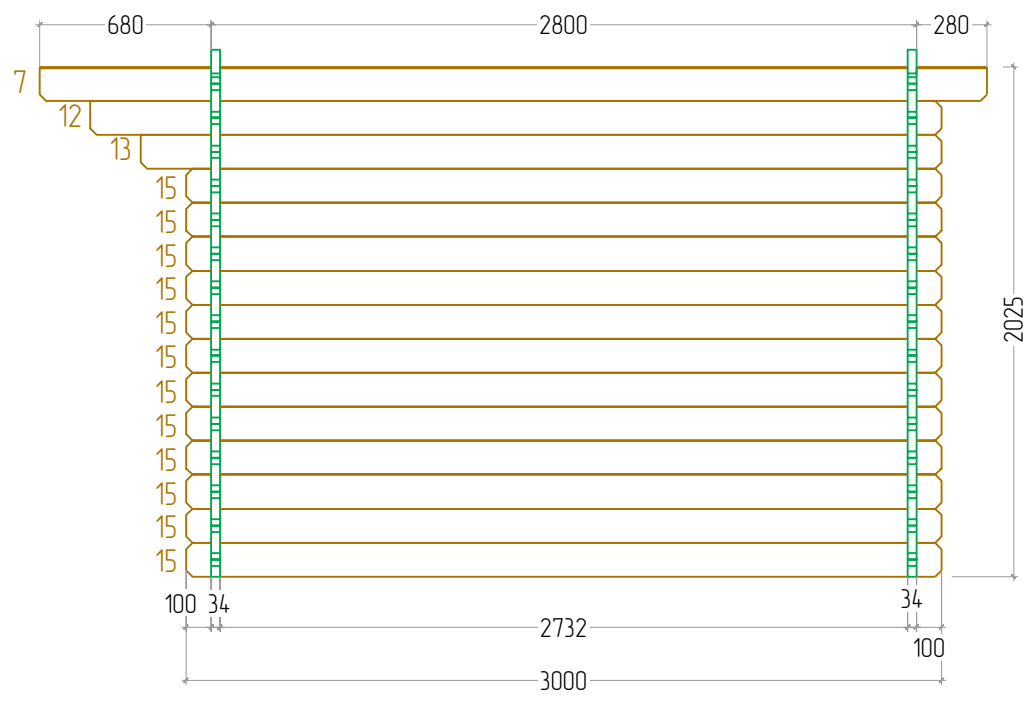

E

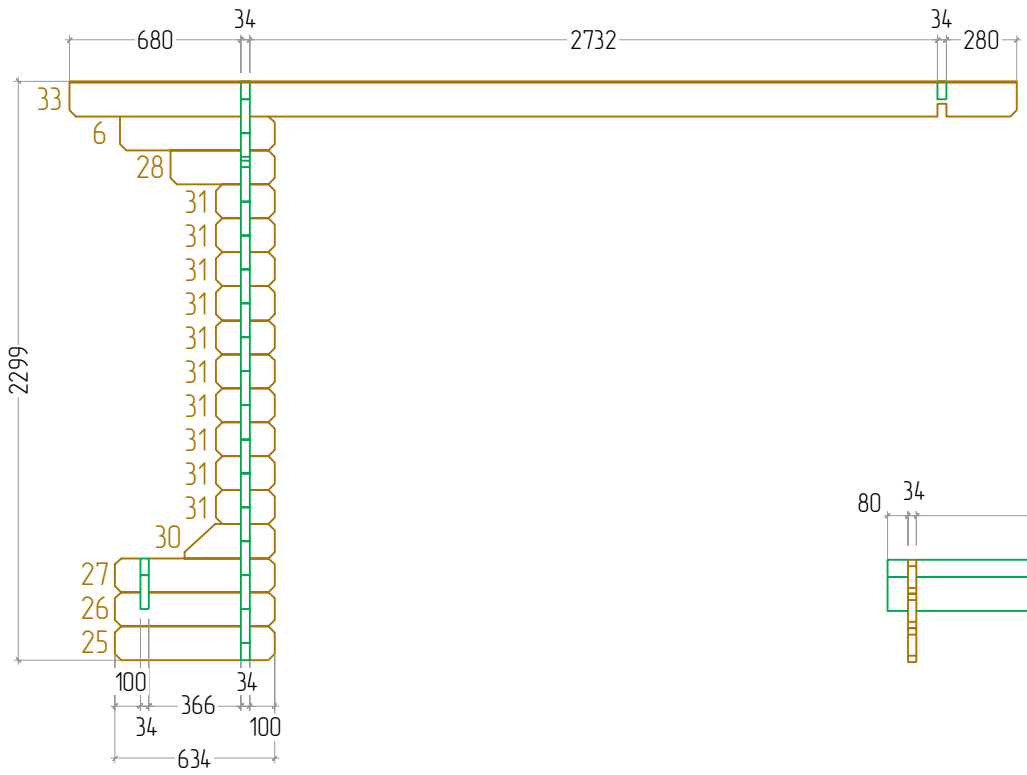

F

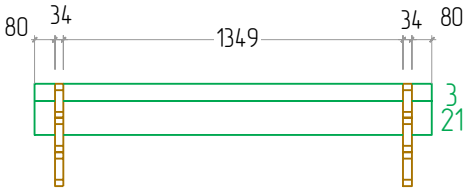

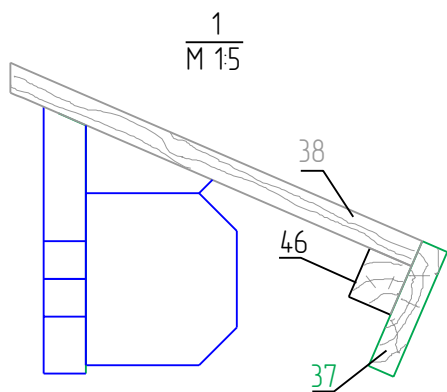
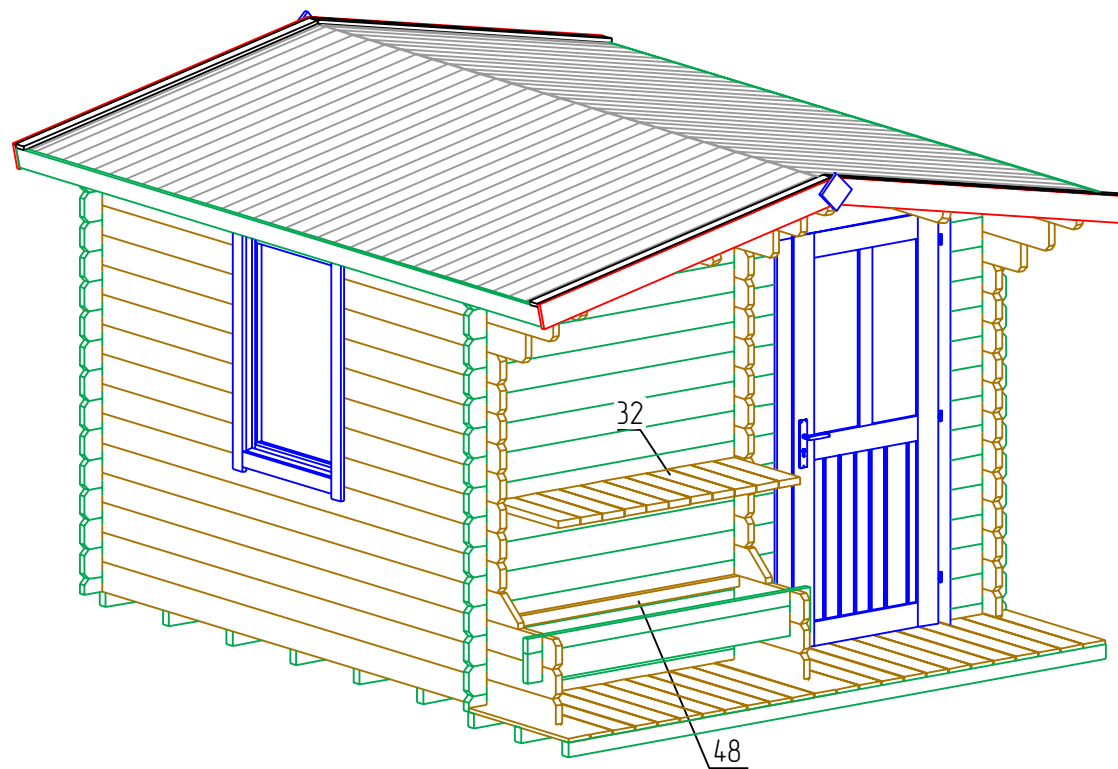
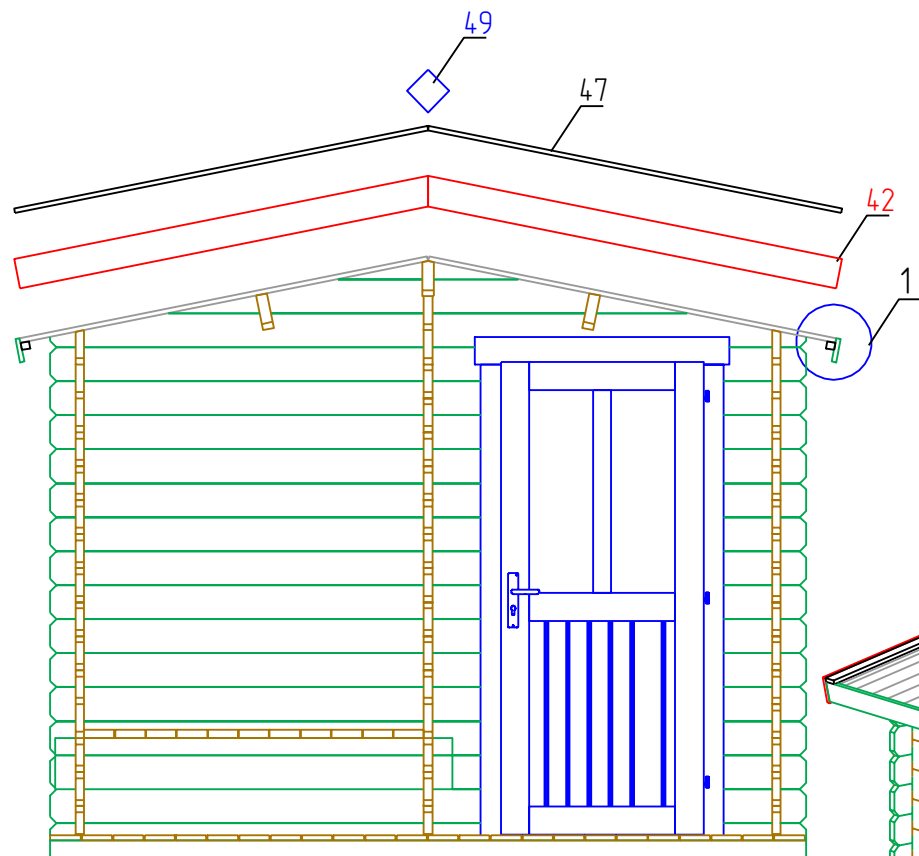

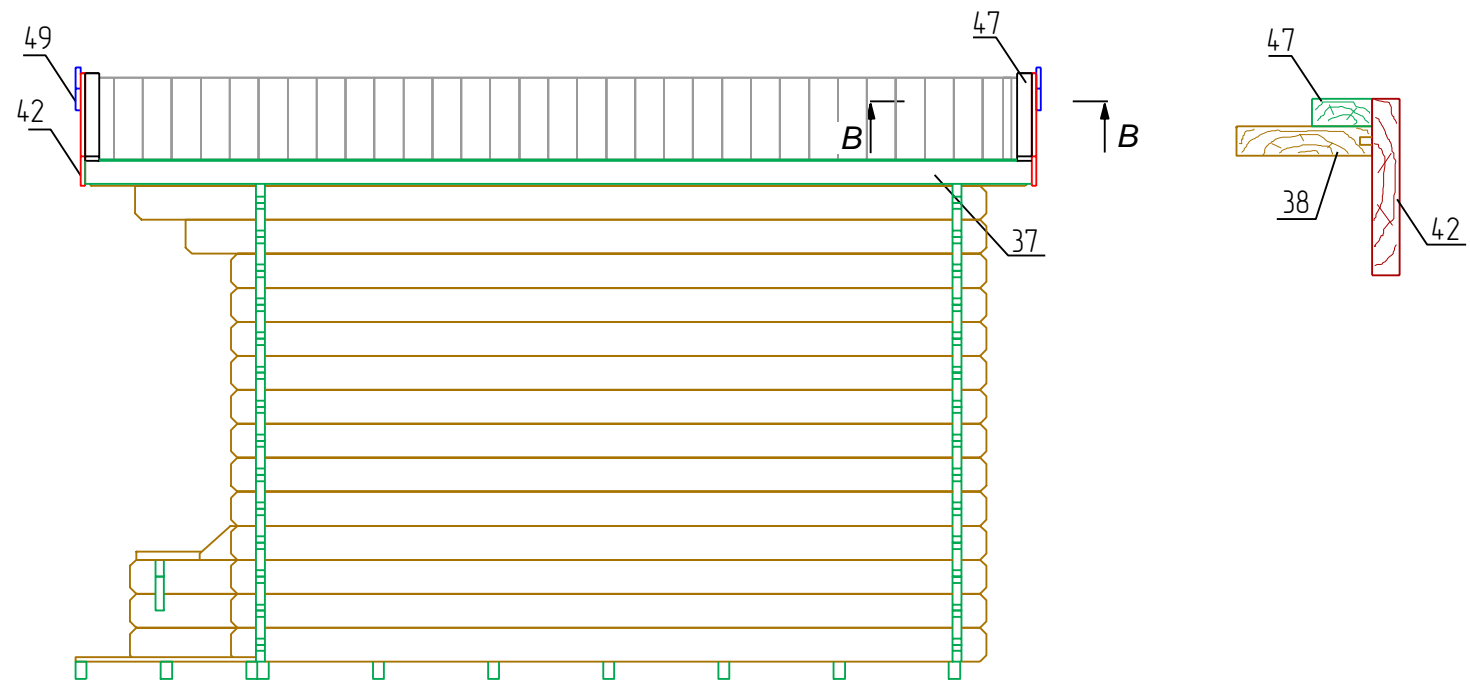

Tom 34 3x3

Boarding joist plan
Trummplan
Lambourde plan

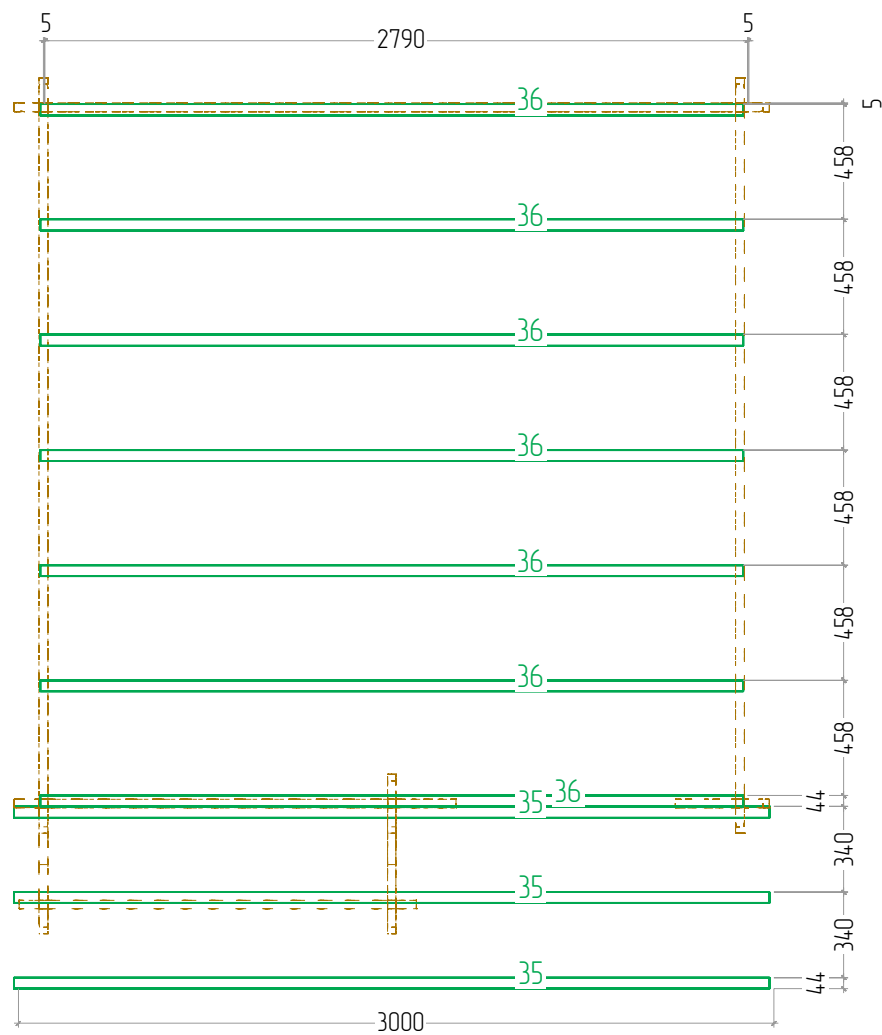





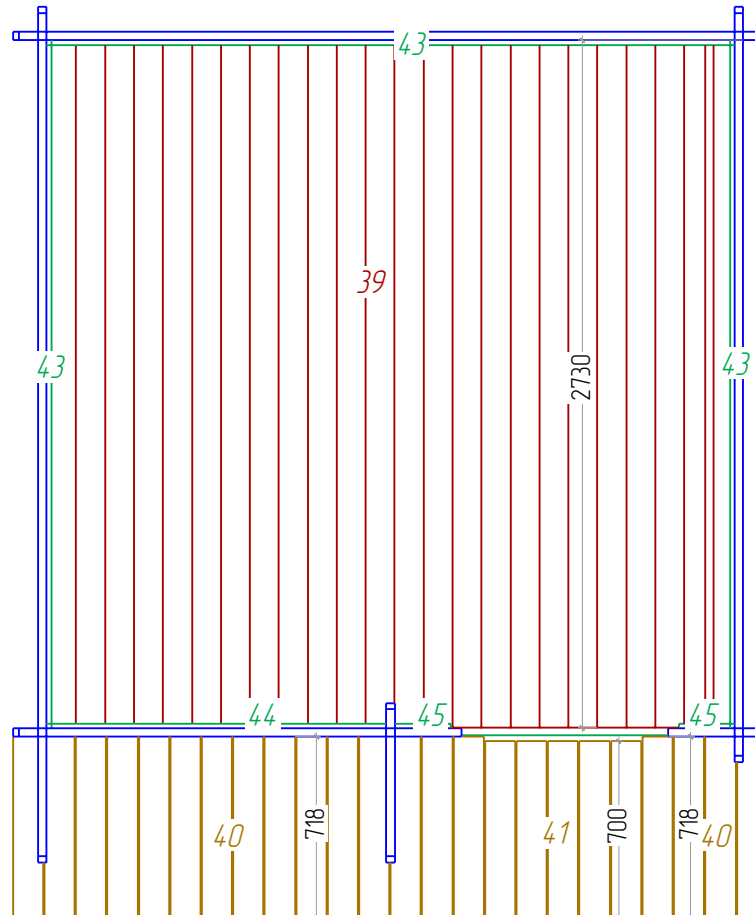







Tom 34 3x3





Plan of the floor board
Plan der furbodenbretter
Le plan des plaches du plancher

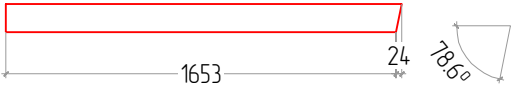

№	Том 34 3x3	St.	Schnittl	Lange
1		1	34x67.5	3000mm
2		1	34x67.5	1756mm
3		1	34x67.5	1577mm
4		1	34x67.5	374mm
6		1	34x134.4	614mm
7		1	34x135	3760mm
8		1	34x135	3760mm
9		1	34x135	3400mm
10		1	34x135	3400mm
11		1	34x135	3400mm
12		1	34x135	3380mm
13		1	34x135	3180mm
14		1	34x135	3125mm

Nº	Tom 34 3x3	St.	Schnitt	Longe
15		28+1	34x135	3000mm
20		14	34x135	1756mm
21		1	34x135	1577mm
22		1	34x135	1520mm
23		1	34x135	1320mm
24		14	34x135	1140mm
25		1	34x135	634mm
26		1	34x135	634mm
27		1	34x135	634mm
28		1	34x135	414mm
29		14	34x135	374mm
30		1	34x135	359mm
31		10	34x135	234mm

Nº	Tom 34 3x3	St.	Schnitt	Länge
32		11	32x120	475mm
33	Roof beam. Dachbalken. Panne 	1	44x140	3760mm
34	Roof beam. Dachbalken. Panne 	2	44x140	3760mm
35	Foundation Fundament Solve 	3	44x68	3000mm
36	Foundation Fundament Solve 	7	44x68	2790mm
37	Roof side boards Traufenbrett Planche de rive 	2	18x95	3760mm
38	Roof boards Dachbretter Volige 	66+1	20x115	1650mm
39	Floor boards Fu ssboden Lame de plancher 	24+1	20x115	2728mm
40		20	18x120	718mm
41		5	18x120	700mm
42	Fascia board Giebelblende Planch de rive facade 	4	18x120	1677mm
43	Floor edge trim Fu bleisten Plinthe plancher 	3	18x20	2732mm
44	Floor edge trim Fu bleisten Plinthe plancher 	1	18x20	1349mm

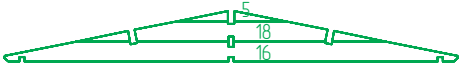
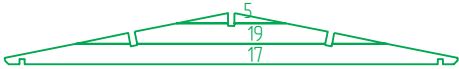
Nº	Tom 34 3x3	St.	Schnittl	Lange
45	Floor edge trim Fu bleisten Plinthe plancher 	2	18x20	197mm
46	Roof edge reinforcement Traufleisten Tasseau 	2	28x34	3760mm
47	Roofing felt fillet Giebelabschlussbrett Latte de finition couverture 	4	18x58	1673mm
48		1	50x34	1349mm
	Door Tur 1958mmx870mm La porte	1		
	Window Fenetre 1080mmx720mm Fenster	1		
49	Diamond Raute Diamant 	2	18x120	120mm
W-1		1		
W-2		1		

W-1

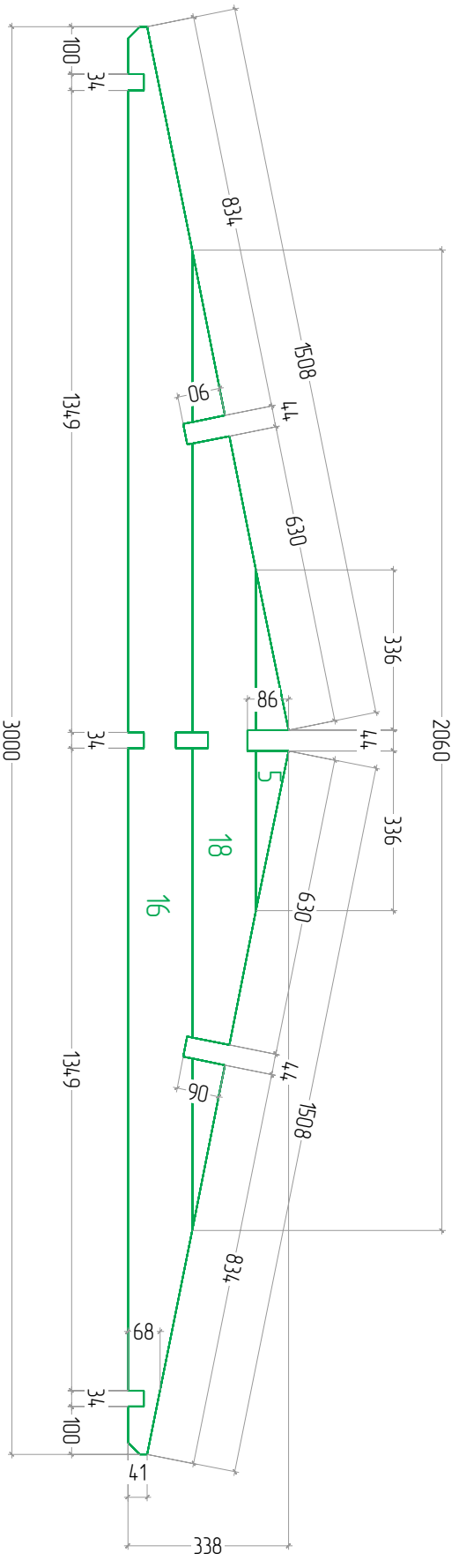

W-2

