

Name	Bertil 300x300+500/44		
Zeichnung/Drawing	3D		
Profil/Profile	4.4x13.5	Datum/Date	22.08.2018

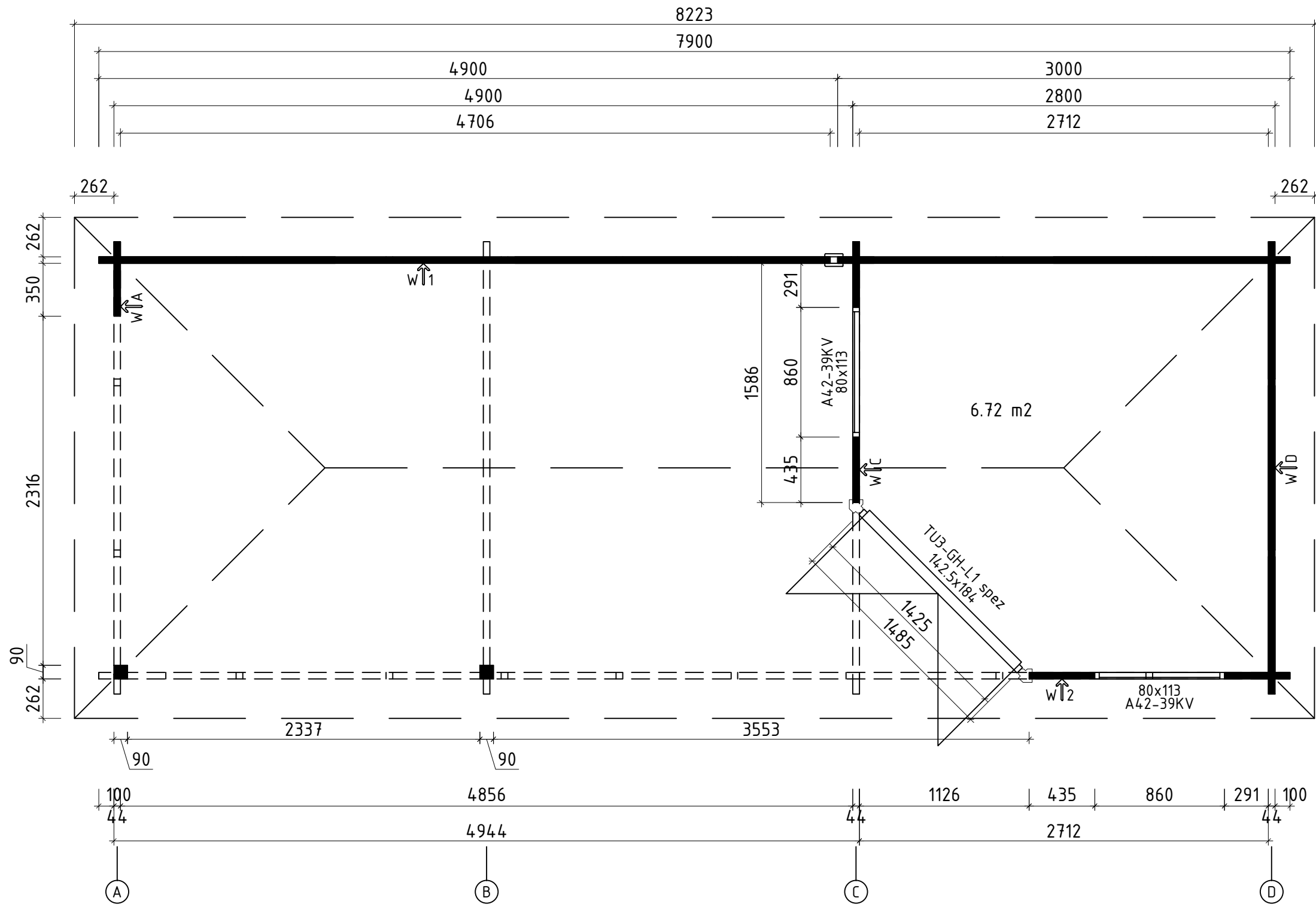

Name	Bertil 300x300+500/44		
Zeichnung/Drawing	Grundplan; Plan		
Profil/Profile	4.4x13.5	Datum/Date	22.08.2018

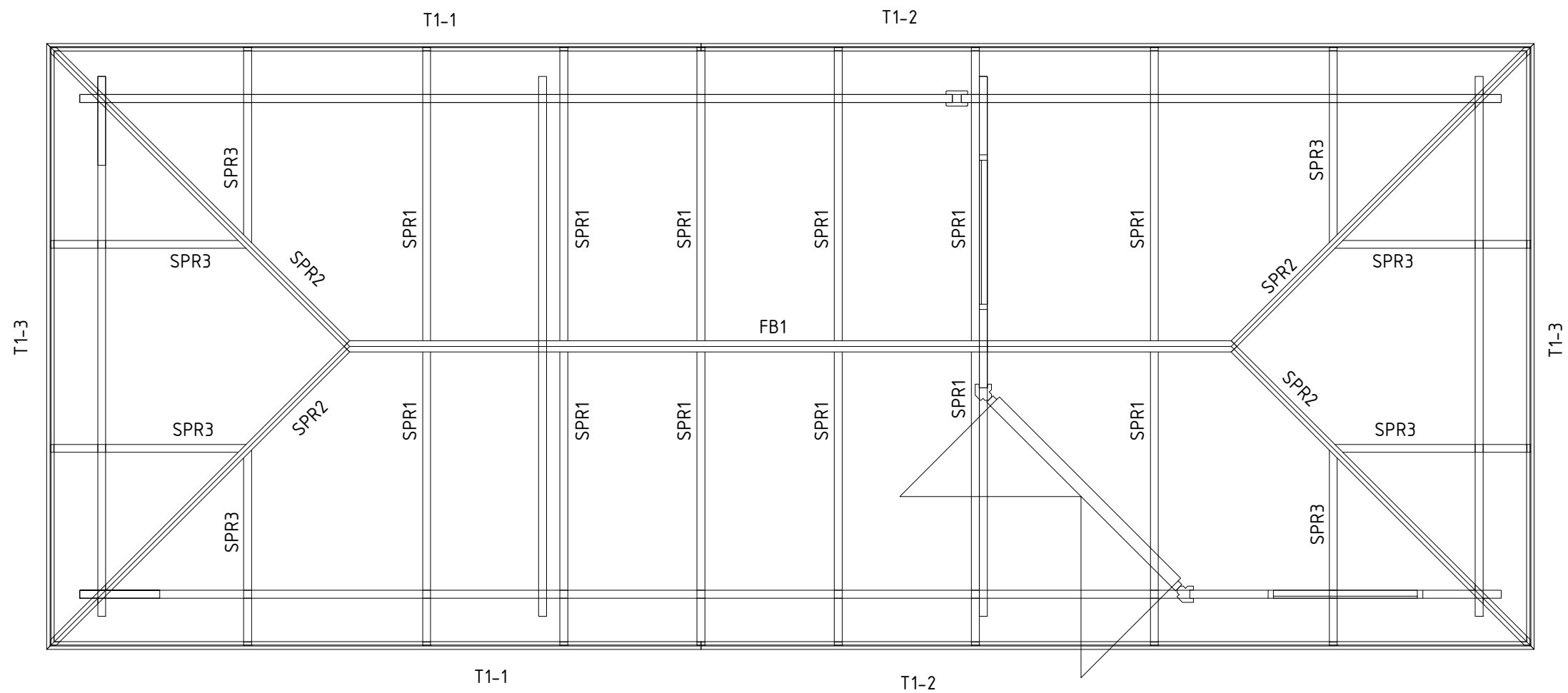

Name	Bertil 300x300+500/44		
Zeichnung/Drawing	Dachplan; Roof plan		
Profil/Profile	4.4x13.5	Datum/Date	22.08.2018

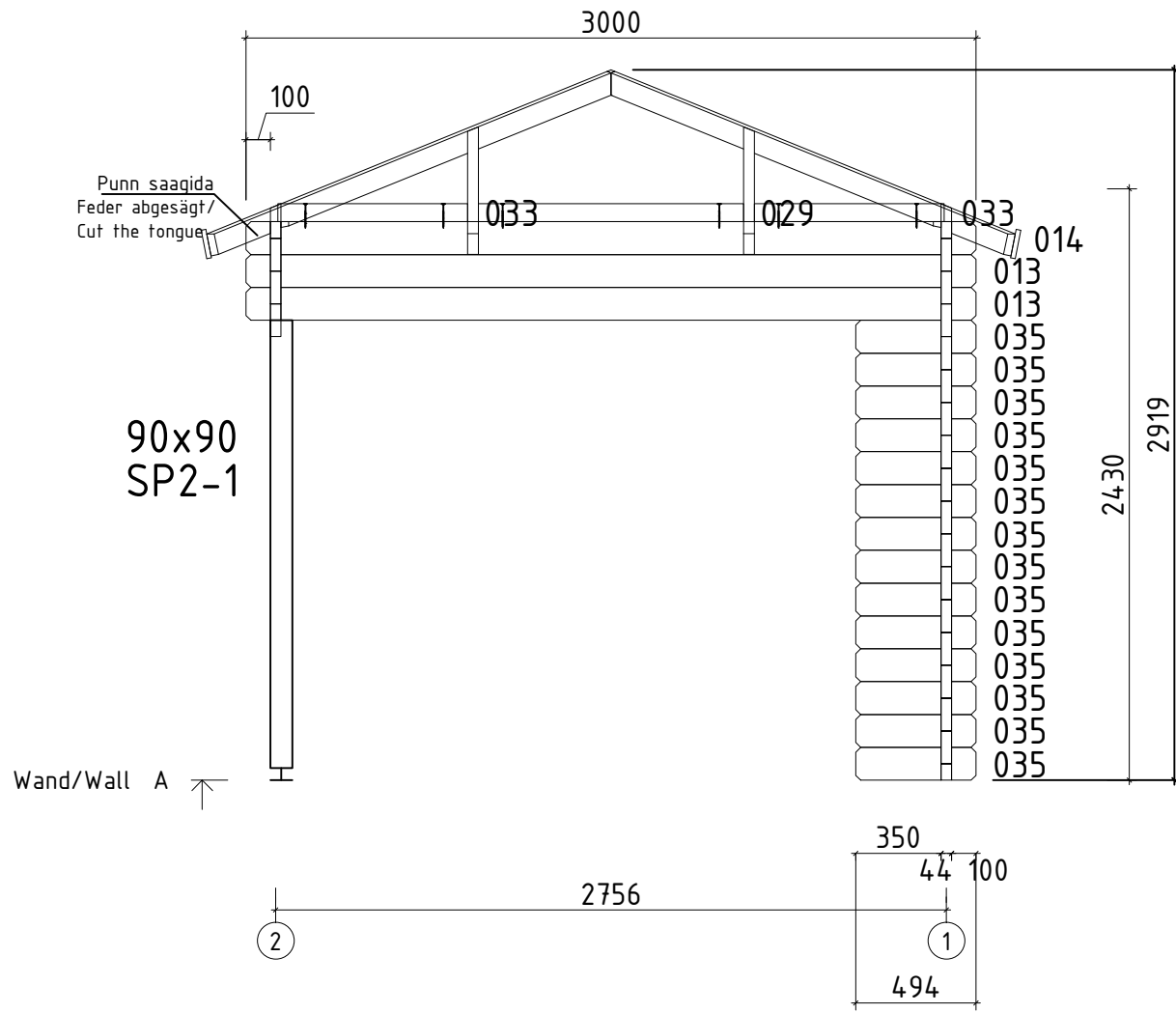

Name	Bertil 300x300+500/44		
Zeichnung/Drawing	WAND/WALL A		
Profil/Profile	4.4x13.5	Datum/Date	22.08.2018

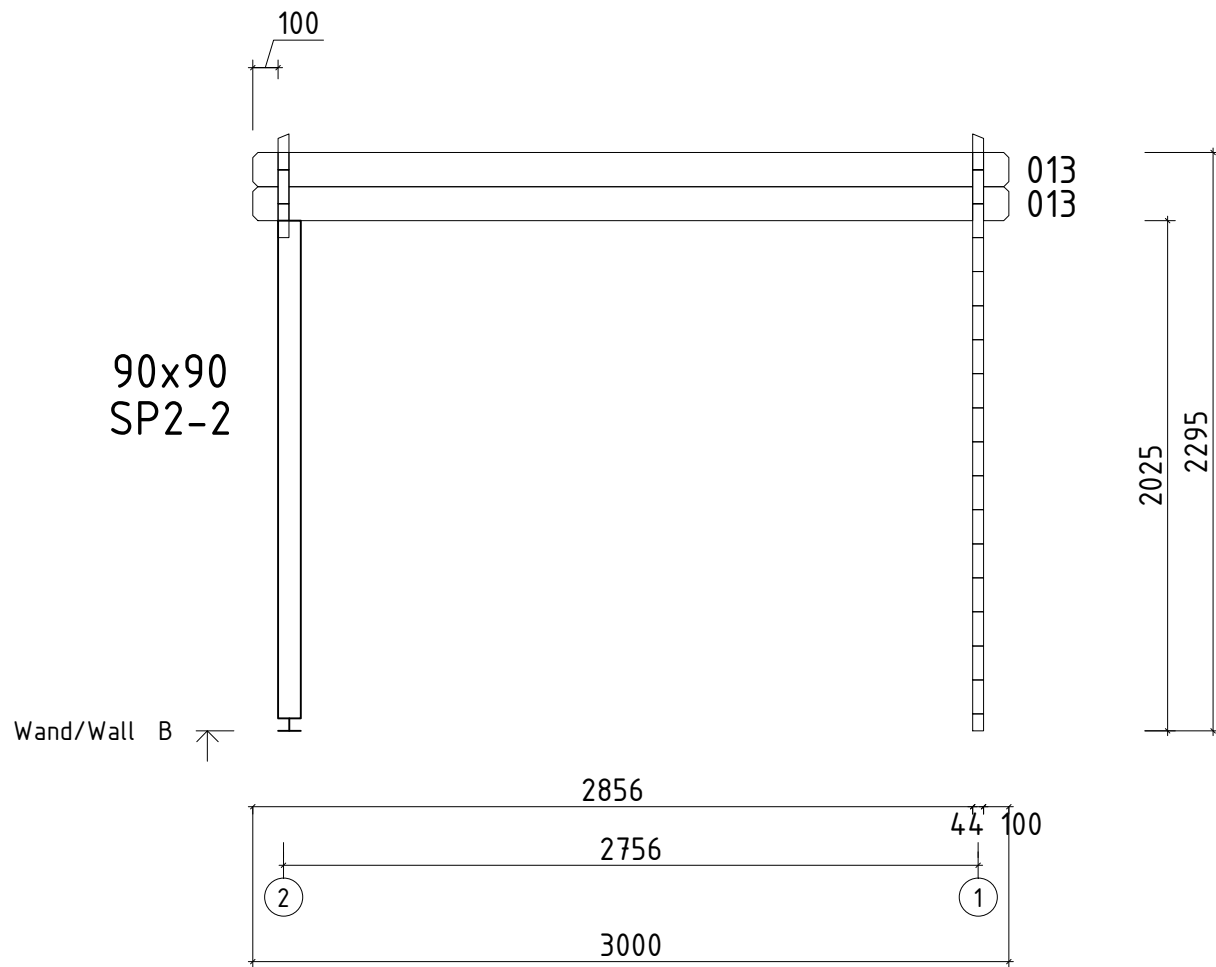

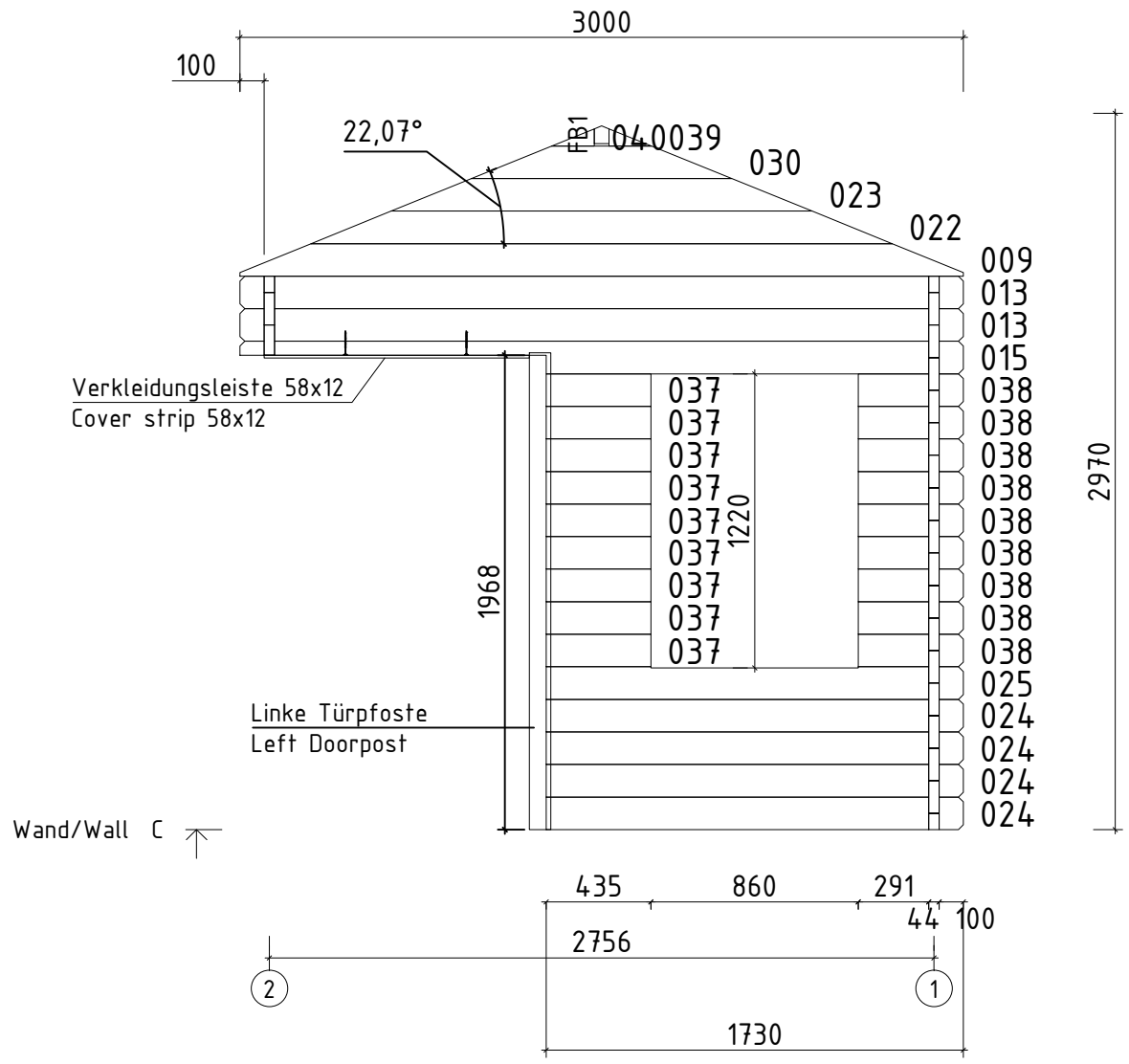

Name	Bertil 300x300+500/44		
Zeichnung/Drawing	WAND/WALL B		
Profil/Profile	4.4x13.5	Datum/Date	22.08.2018



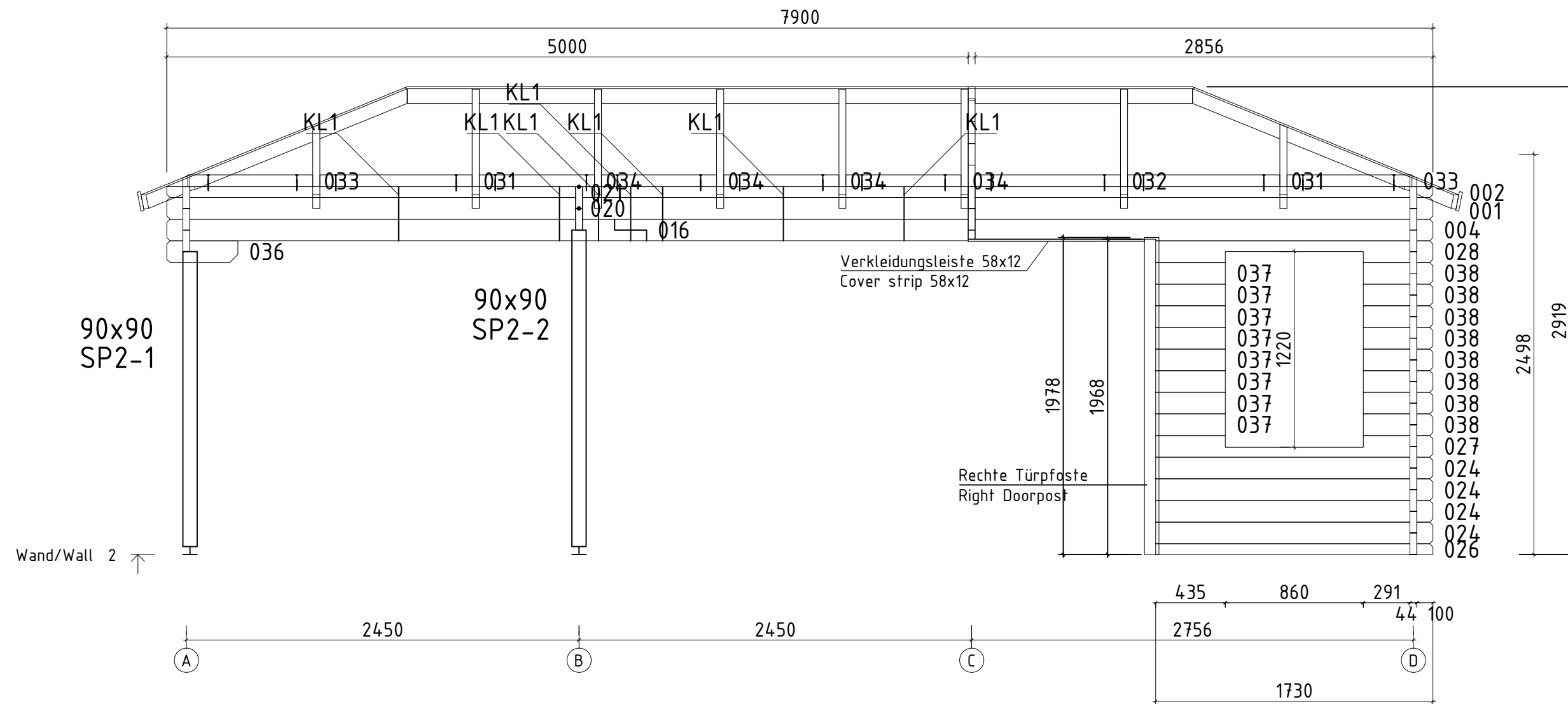



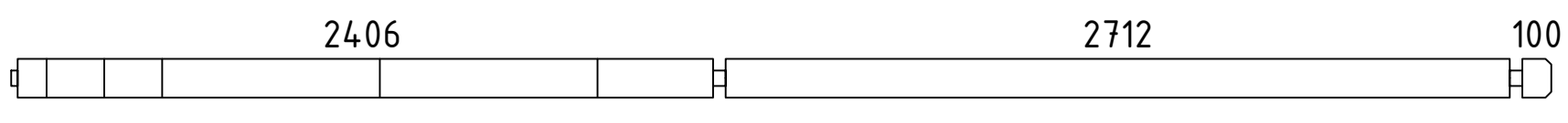
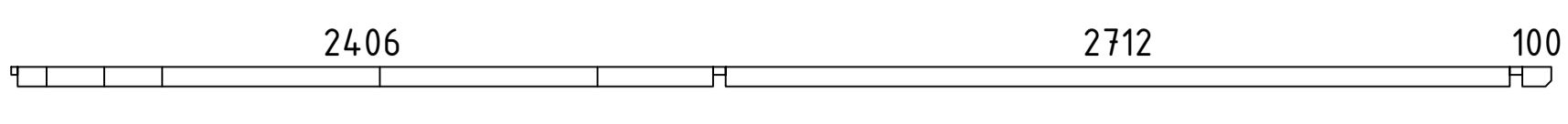
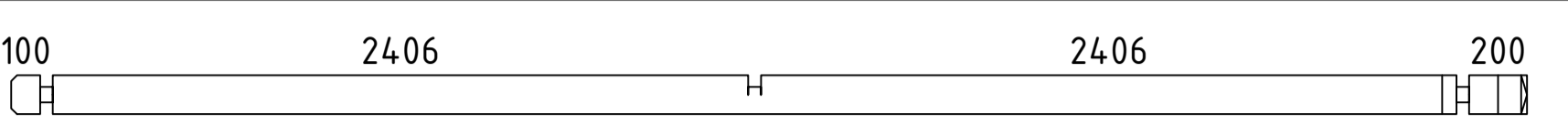
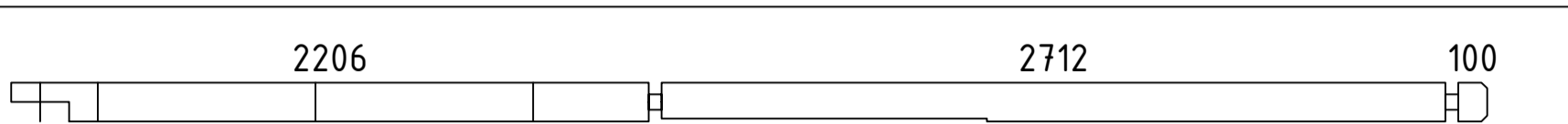
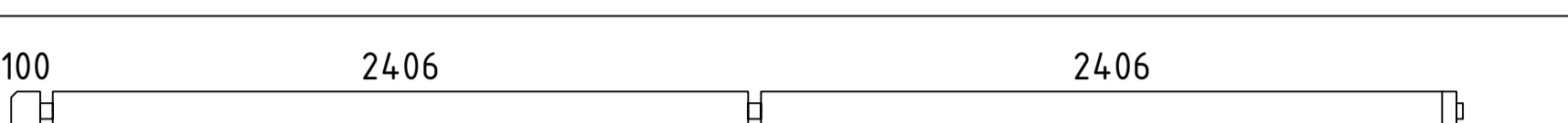
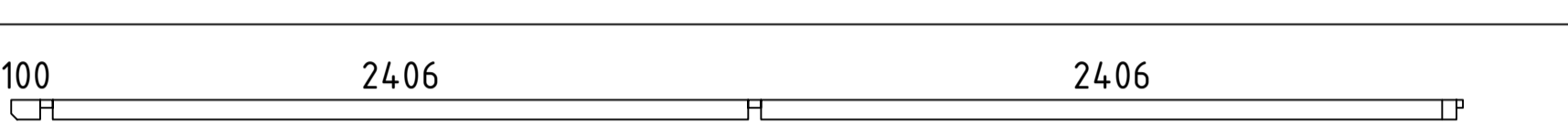
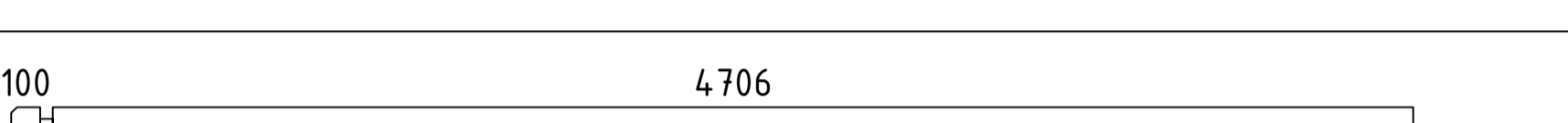
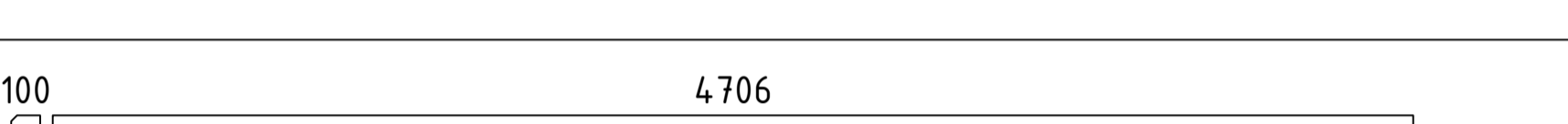
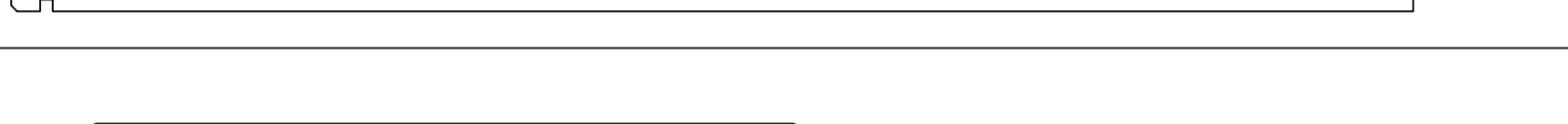
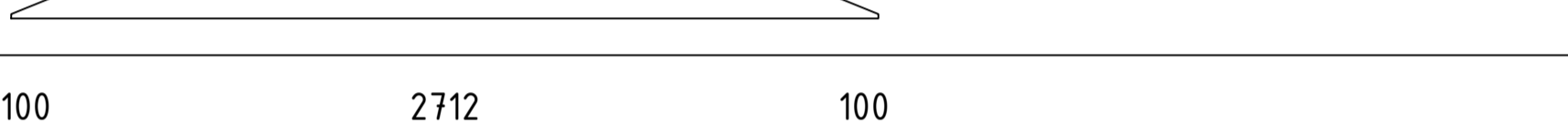
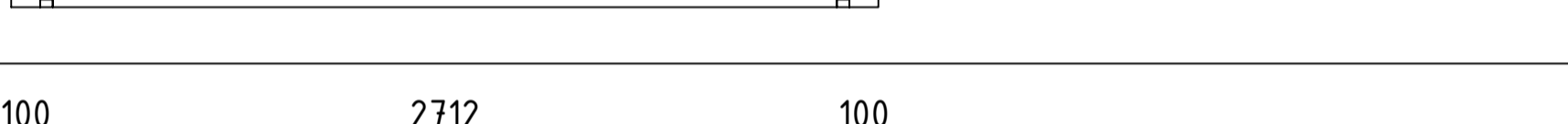
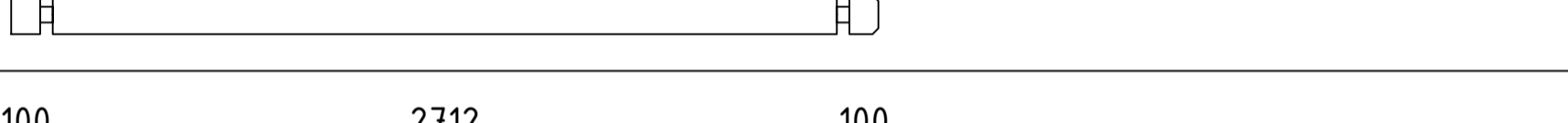
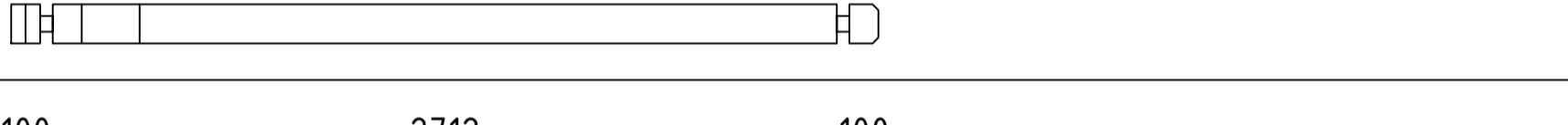
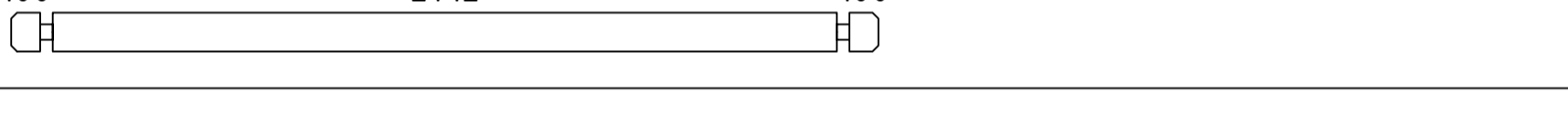
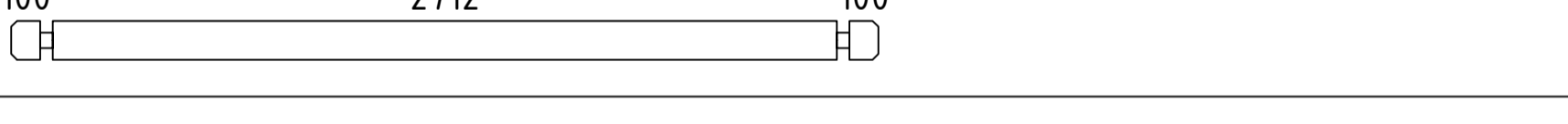
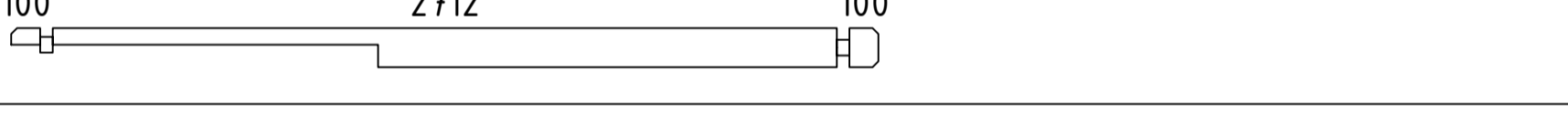
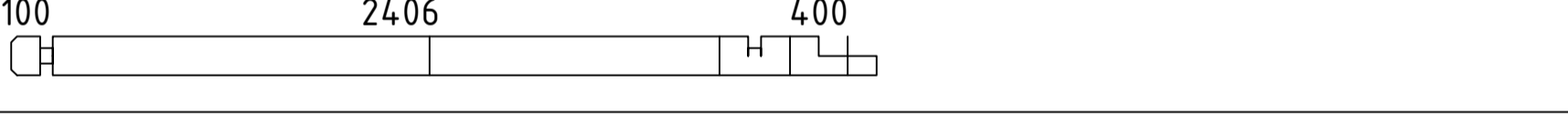
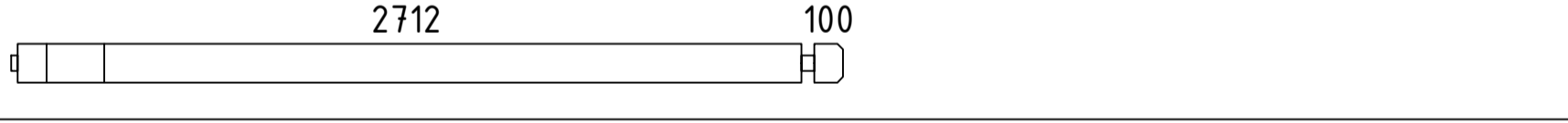
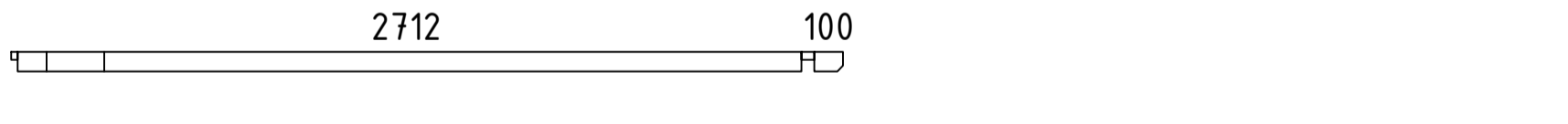
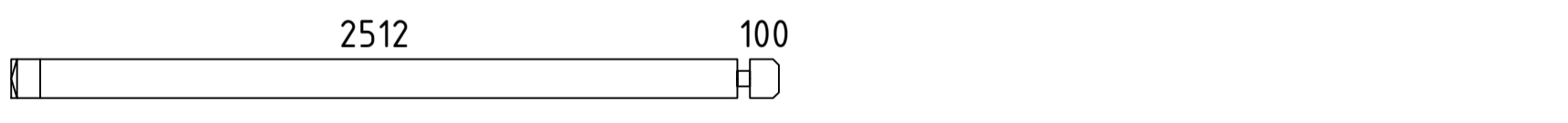
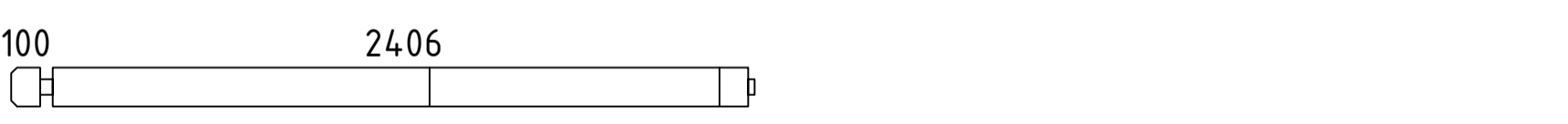
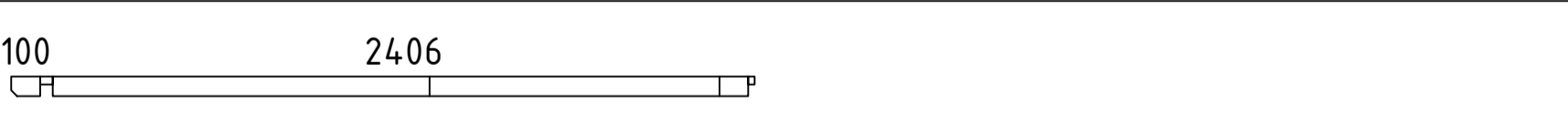
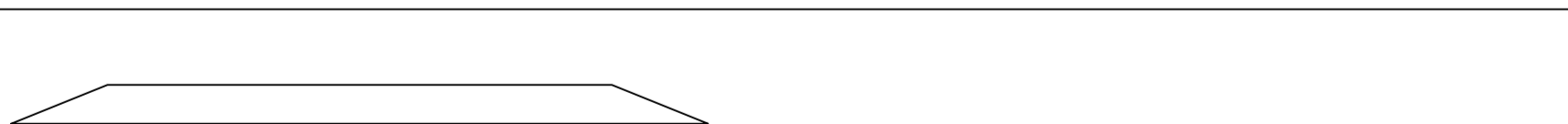



Name	Bertil 300x300+500/44		
Zeichnung/Drawing	WAND/WALL C		
Profil/Profile	4.4x13.5	Datum/Date	22.08.2018

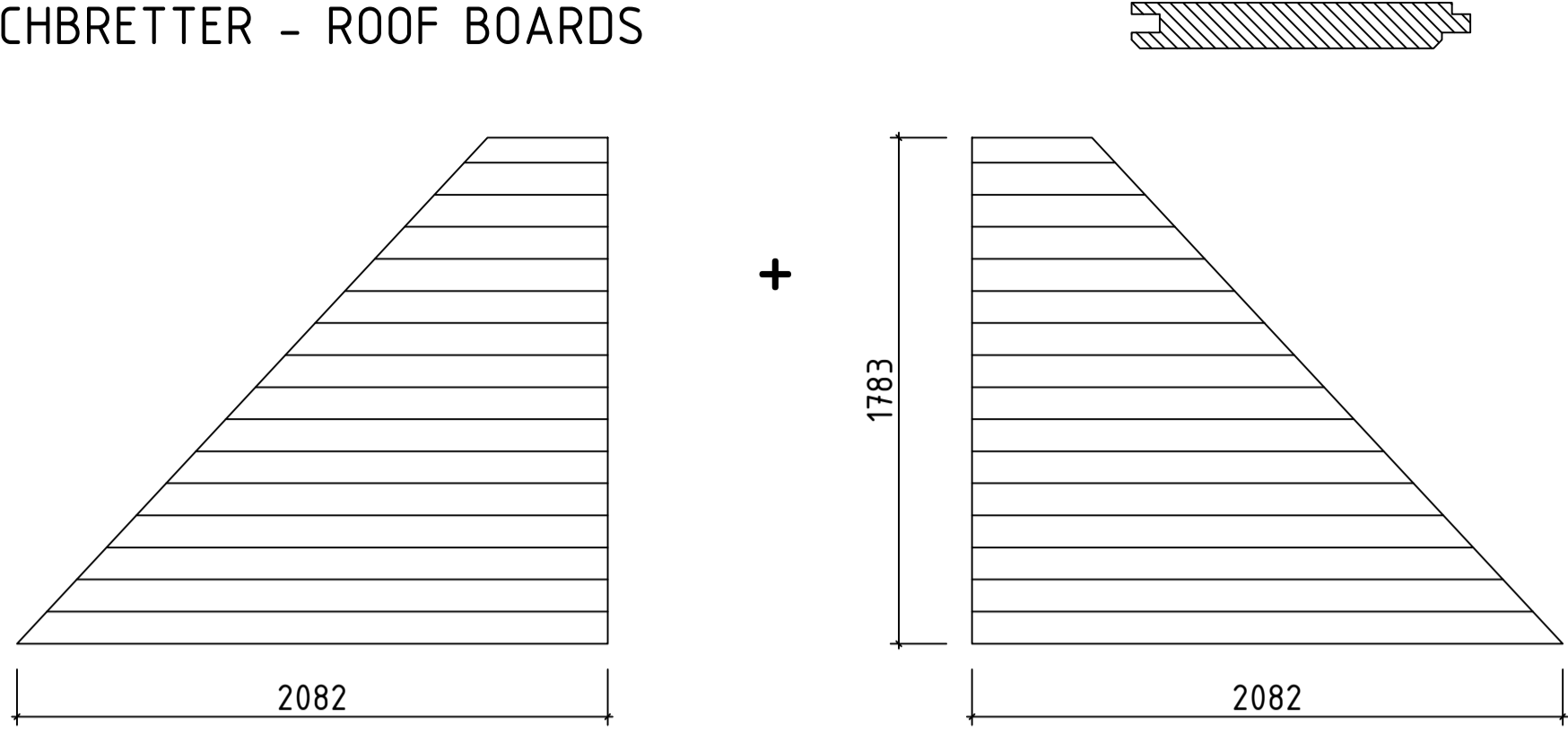

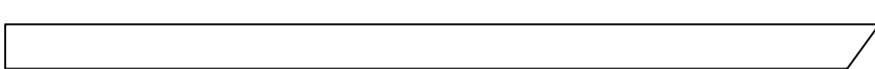
Name	Bertil 300x300+500/44		
Zeichnung/Drawing	WAND/WALL 2		
Profil/Profile	4.4x13.5	Datum/Date	22.08.2018

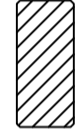
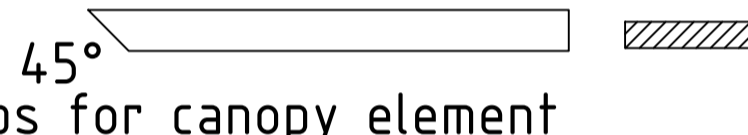
Pos	Teileliste/Specification Bertil 300x300+500/44	Stck. Pcs.	Profil Profile (mm)	Länge Length (mm)
001		1	44x135	5328
002		1	44x68	5328
003		1	44x135	5244
004		1	44x135	5106
005		1	44x135	5022
006		1	44x68	5022
007		1	44x68	4850
008		14	44x135	4850
009		1	44x135	3000
010		1	44x68	3000
011		13	44x135	3000
012		1	44x135	3000
013		22	44x135	3000
014		2	44x135	3000
015		1	44x135	3000
016		1	44x135	2994
017		1	44x135	2878
018		1	44x68	2878
019		1	44x135	2656
020		1	44x135	2572
021		1	44x68	2572
022		1	44x135	2411
023		1	44x135	1745
024		8	44x135	1730
025		1	44x135	1730

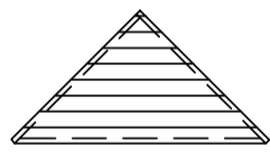
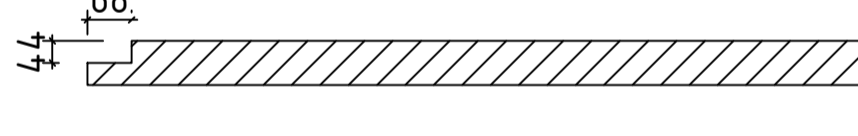
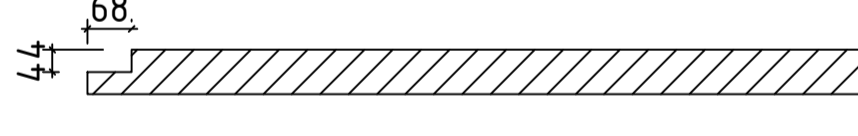
Pos	Teileliste/Specification Bertil 300x300+500/44		Stck. Pcs.	Profil Profile (mm)	Länge Length (mm)
026			1	44x68	1730
027			1	44x135	1730
028			1	44x135	1730
029			2	44x74	1090
030			1	44x135	1079
031			4	44x74	951
032			2	44x74	906
033	Draufsicht 	✓	4+4	44x74	780
034			8	44x74	719
035			14	44x135	494
036			1	44x135	444
037			17	44x135	435
038			17	44x135	435
039			1	44x71	176
040			1	44x71	176
SPR2	SPARREN - RAFTERS 		4	44x94	2422
SPR1	SPARREN - RAFTERS 		12	44x85	1774
SPR3	SPARREN - RAFTERS 		4+4	44x85	1187
FB1	FIRSTBOHLE - RIDGE BOARD 		1	62x105	4962
	DACHBRETTER - ROOF BOARDS 		32+1	113x16	4045
	DACHBRETTER - ROOF BOARDS 		2	113x16	
Kood	Bertil 300x300+500/44	Materjal	File	Bertil 300x300+500-44.dwg	Leht 2/4

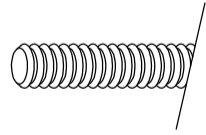
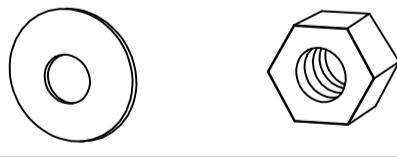
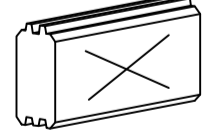
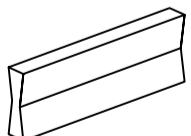
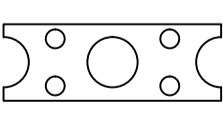
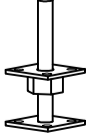
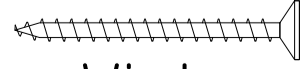
Pos	Teileliste/Specification Bertil 300x300+500/44		Stck. Pcs.	Profil Profile (mm)	Länge Length (mm)
	DACHBRETTER - ROOF BOARDS 		2+2	113x16	
T1-1	TRAUFBRETTER - EAVES BOARDS 120X18 	✓	1+1	120x18	3690
T1-2	TRAUFBRETTER - EAVES BOARDS 120X18 	✓	1+1	120x18	4680
T1-3	TRAUFBRETTER - EAVES BOARDS 120X18 	✓	2	120x18	3420
A44-1	ADAPTER 120x82 	✓	1	120x82	2160
DzT 58-1	ECKTÜR- Deckbrett zum Tür - CORNER DOOR- cover strip for door 58 		1	18x58	1585
VK1-1	ECKTÜR- Verkleidungsleisten für Vordachelement - CORNER DOOR- trim strips for canopy element 	✓	2	58x12	1100
P9L-1	ECKTÜR- linke Türpfoste - CORNER DOOR- left hand doorpost 90 		1	90x90	1980
P9R-1	ECKTÜR- rechte Türpfoste - CORNER DOOR- right hand doorpost 90 		1	90x90	1980
VE1	ECKTÜR- Vordachelement - CORNER DOOR- canopy element 1435x745 		1		
SP2-1	STÜTZPFOSTE - SUPPORT POST 90x90 	✓	1	90x90	2190
SP2-2	STÜTZPFOSTE - SUPPORT POST 90x90 	✓	1	90x90	2325
ML1	Metallstange - Metal bar 		3	D10	500
KL1	Gewindestange - Threaded Rod M8 		7		338
	Mutter - nut M8 U-Scheibe - washer Ø25 		14		
SH	SCHLAGHÖLZER - MOUNTING PIECES 		3		
HK2	HOLZ-KLOTZEN für verbinden der Wandbohlen - Wooden wedge for connecting the wall parts (122mm) 		1		
VS	VERBINDUNGSSTREIFEN für verbinden der Wandbohlen - Connecting strip for connecting the wall parts 		4		
VP2	Verstellbare Pfostenstütze - Adjustable post support M16 		2		
SR03	SCHRAUBEN - SCREWS 3.5x45 VS Fenster- und Türleisten - Window and Door strips 		88		
Kood	Bertil 300x300+500/44	Materjal	File	Bertil 300x300+500-44.dwg	Leht 3/4

Cutting support post / Schneiden der Stützpfosten



- * Adjustment space for post support should be at least 50mm.

* Einstellraum für die Pfostenstütze muss mindestens 50mm sein.

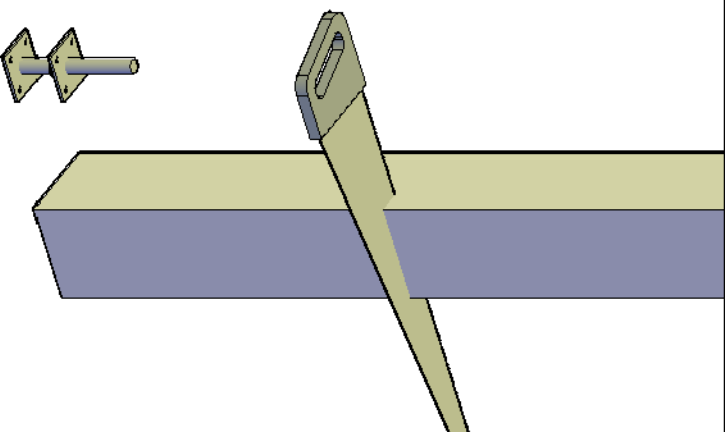

- * Support post has extra length for various conditions. Must be sawn to suitable length on spot considering local conditions.

* Stützpfosten hat extra Länge für verschiedene Bedingungen. Muss vor Ort unter Berücksichtigung der örtlichen Gegebenheiten zu einer geeigneten Länge gesägt werden.

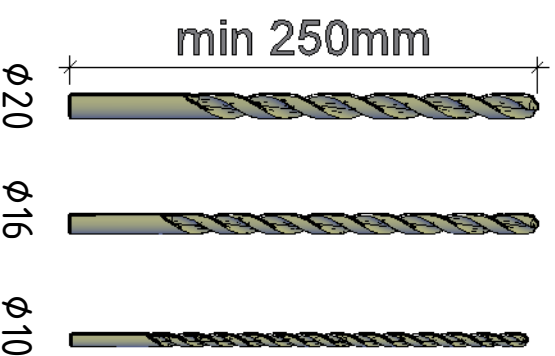
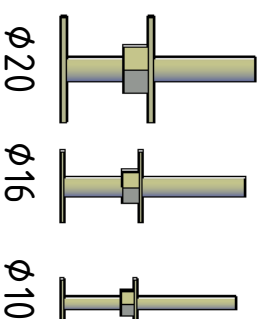

- * In some cases you need to drill a new hole for a post support. Find a matching drill bit.

* In einigen Fällen müssen Sie ein neues Loch für die Pfostenstütze bohren. Finden Sie hier den passenden Bohrer.

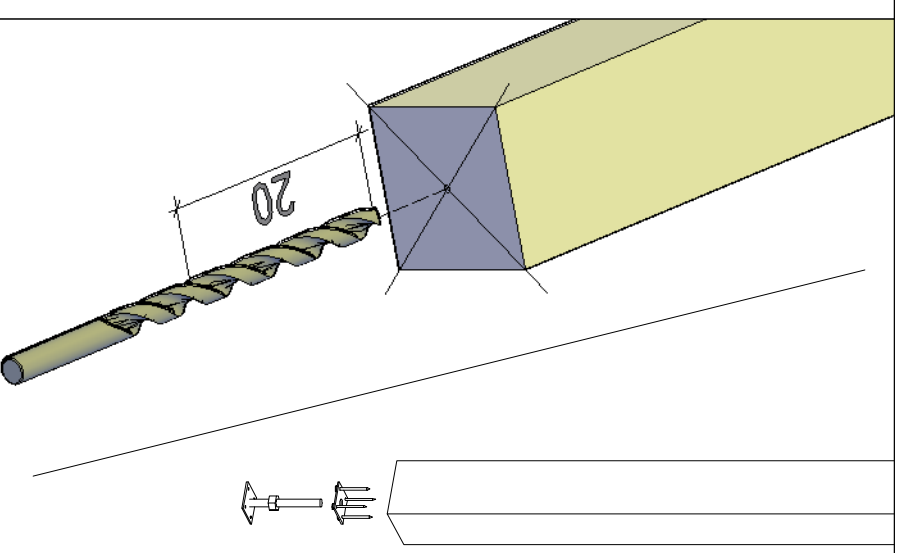

- * Mark the center of the post and drill a new 20cm deep hole.

Continue building.
* Markieren Sie die Mitte des Pfostens und bohren Sie ein neues 20cm tiefes Loch. Danach mit Aufbau weiter machen.